

## SPECIAL PURPOSE VEHICLE

# SIDE THRUST ROLLERS

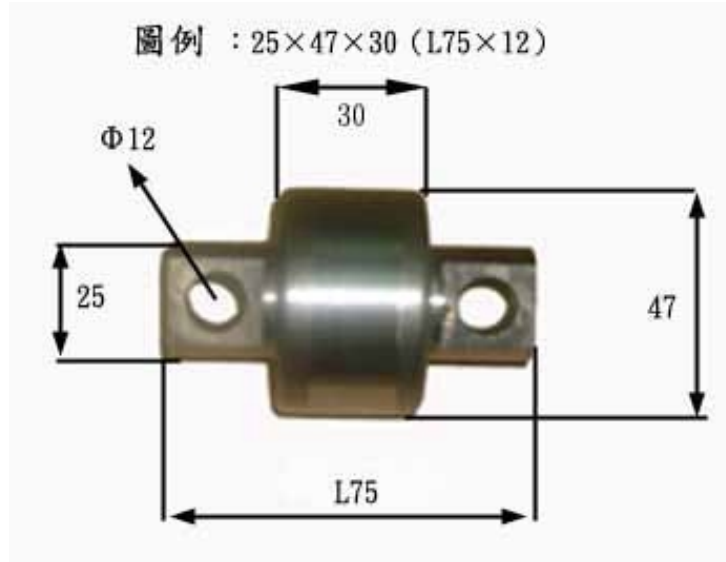





Photo Reference.	Specifications Pin w.x bearing W. x bearing H.	Make	Model no.	Remarks
	17*47*22(L65*11) Pin hole w/o thread	TCM 心無牙	SR-2227	PCD45
	17*47*22(L65*11) Pin hole w/o thread	TCM 心有牙	SR-2227-1	
	T18*38*24 Raise & Fall Bearing Pin hole w/o thread	KOMATSU FD30	SR-2202 (81200) XR-1057-2 (KOYO) 46B-225-1370	PCD36
	20*41*30(L70.5*9)	NISSAN FB15 心無牙	SR-2226-4	
	20*42*30(L80*10) Pin hole w/thread	TCM 1.5T 圓心有牙	SR-2219-3 94010-08700	PCD60
	20*42*30(L80*11) Pin hole w/o thread	TCM 3T W3/T7 雙平,心無牙	SR-2245 23458-32051	PCD60

## SPECIAL PURPOSE VEHICLE

Photo Reference.	Specifications Pin w.x bearing W. x bearing H.	Make	Model no.	Remarks
	20*42*30(L80*11)	半圓心,無牙	SR-2245-1 <b>94010-09700</b>	
	20*42*36(L80*10) Pin hole w/thread	MITSUBISHI S4E	SR-2219 <b>94211-05700</b>	PCD60
	20*42*36(L80*10.5) Pin hole w/o thread (Bias)	MITSUBISHI 1.5T S4E 心無牙	SR-2219-1	PCD60
	20*42*36 (L85*10.5)	NISSAN	SR-2254 <b>59532-L1100</b>	PCD60
	20*58*30(L80*12.5) Pin hole w/thread	心有牙	SR-2204 (A102) <b>23458-32051</b>	PCD60
	20*58*30(L80*12.5) Pin hole w/thread	心無牙	SR-2208 (A103) <b>23458-32051</b>	PCD60
	22*40*30(L75*9) Pin hole w/o thread	NISSAN FB15	SR-2226	PCD55
	22*40*30(L75*11) Pin hole w/o thread	NISSAN FB15	SR-2226-1	PCD55
	22*40*30(L80*11) Pin hole w/o thread	NISSAN(NEW) TCM FD15 700S	SR-2226-2	PCD60
	22*45*24 Raise & Fall Bearing Pin hole w/o thread	TOYOTA 3F 芯51.6m/m	SR-2201 <b>63382-30800-71</b>	PCD40
	24*51*30 Raise & Fall Pin hole w/o thread	TOYOTA 3/5FD30	SR-2232 <b>84634-38200-71</b>	PCD45









## SPECIAL PURPOSE VEHICLE

Photo Reference.	Specifications Pin w.x bearing W. x bearing H.	Make	Model no.	Remarks
	24.5*47*30(L75*10) Pin hole w/thread 1.25	NYK 1.5T NYK 2.5T 心有牙	SR-2206 (A101) <b>4624-65250</b>	PCD55
	25*40*50 (L84*5)	NISSAN ELECTRIC TYPE	SR-2257	
	25*47*30(L75*11)	心無牙	SR-2207-1	
	25*47*30(L75*12) Pin hole w/o thread	NISSAN 2.5T NISSAN 6T	SR-2207 (L2901) <b>59532-L2901</b>	PCD55
	25*47*30(L80*13) Pin hole w/o thread	YALE 2T	SR-2205 (33401) <b>234A8-33401</b>	PCD60
	25*52*25(L63*9) Pin hole w/o thread (Match w/40*78*26)	YANG 2.5T (NEW)	SR-2243	PCD45
	25*52*30(L60*8.5)	YALE 2.5T 側滾輪	SR-2260	PCD46
	25*52*30(L84*10) Pin hole w/thread (concentric)	MITSUBISHI 4T	SR-2219-2	PCD60
	25*52*36(L85*10) Pin hole w/thread	MITSUBISHI 4T	SR-2214 <b>94401-03500</b>	PCD60
	25*54*30(L80*12) (扁心) Pin hole w/o thread (Bias-12m/m)	TCM 2.5T T6	SR-2239	PCD60

## SPECIAL PURPOSE VEHICLE

Photo Reference.	Specifications Pin w.x bearing W. x bearing H.	Make	Model no.	Remarks
	25*54*30(L80*12.5)(扁心) Pin hole w/o thread (Bias-16m/m)	TCM 2.5T T6	SR-2239-1 <b>23458-32052</b>	PCD60
	25*58*30(L80*12) Pin hole w/o thread	TCM 2.5T	SR-2211 (MRS-10) <b>23458-32051</b>	PCD60
	25*58.5*22(L74*12.5) Pin hole w/thread	TOYOTA 7FD20 ELECTRIC TYPE	SR-2238	PCD52
	25*62*18(L74*13)(扁心) Pin hole w/o thread (Bias)	TOYOTA 7FD25 邊滾輪	SR-2215	PCD52
	25*62*18(L74*13)		SR-2215-1	
	25*62*20(L74*13) (扁心) Pin hole w/o thread	TOYOTA 5F 貨櫃拱	SR-2216	PCD52
	25*62*20(L70*13)	心有牙	SR-2216-1	
	25*62*24(L68*13) Pin hole w/o thread	TOYOTA 5FD25	SR-2229	PCD52
	25*65*22(L74*13) (扁心) Pin hole w/o thread	TOYOTA 6/7FD15/25 (牙排)	SR-2217 <b>76451-30170-71</b>	PCD52
	25*65*25(L70*10) Pin hole w/thread		SR-2236	PCD50
	25*65*25(L70*11) Pin hole w/thread	TAILIFT 2.5T	SR-2237-1	PCD52

## SPECIAL PURPOSE VEHICLE

Photo Reference.	Specifications Pin w.x bearing W. x bearing H.	Make	Model no.	Remarks
	25*65*25(L74*13) Pin hole w/thread		SR-2237	PCD52
	25*67*26(L70*11) Pin hole w/o thread	KOMATSU 11S NISSAN FD25	SR-2210	PCD52
	25*67*32.5(L85*12.6) Pin hole w/o thread	TCM 4T TOYOTA 5FD30	SR-2212	PCD65
	25*67*33(L85*11) Pin hole w/o thread	TCM 4T	SR-2231 <b>23818-20302</b>	PCD65
	25*68*26(L70*10) Pin hole w/o thread	TCM 2.5T	SR-2222	PCD50
	25*70.5*22(L74*12.5)	TOYOTA 7FD25	SR-2253	
	25*72*28/28(L85*10.5)	TOYOTA 8FD25	SR-2263	PCD62
	25*74*25(L70*10) Pin hole w/thread (semicircle-18m/m)	TAILIFT 2.5T	SR-2223	PCD50
	25*74*25(L70*10) Pin hole w/thread (semicircle-15m/m)	TOYOTA 7FD25	SR-2223-1	PCD50
	25*80*22(L70*13) Pin hole w/o thread	TCM 2.5T	SR-2218	PCD50

## SPECIAL PURPOSE VEHICLE

Photo Reference.	Specifications Pin w.x bearing W. x bearing H.	Make	Model no.	Remarks
	25*80*23(L70*13) Pin hole w/o thread	TCM 2.5T D700 心無牙	SR-2213 <b>22548-30601</b>	PCD50
	25*80*23(L70*13) Pin hole w/thread	TCM 2.5T Z-2 心有牙	SR-2221	PCD50
	25*80*23.6(L72*12.5) Pin hole w/o thread (Bias-T. 14m/m)	TOYOTA 5FD25/40	SR-2225	PCD52
	25*80*23.6(L74*10.5)	TOYOTA 8FD25	SR-2233-2	
	25*80*23.6(L74*13) Pin hole w/o thread (Bias-9m/m)	TOYOTA 6FD30/7FD25 (牙排)	SR-2233	PCD52
	25*80*25(L70*10) Pin hole w/thread	YANG 3.5T	SR-2248	PCD50
	25*82*23(L70*10)	心有牙	SR-2240-1	
	25*82*23(L70*13) Pin hole w/thread		SR-2240	PCD50
	27.5*52*30(L96*13) Pin hole w/o thread	SUMITOMO 4T	SR-2220-1 <b>9094823-00</b>	PCD74
	28*52*30(L95*13) Pin hole w/o thread	TOYOTA 4T (夾包)	SR-2220	PCD74
	30*83*36(L90*13) Pin hole w/o thread	TCM 6T-10T	SR-2234	PCD70

## SPECIAL PURPOSE VEHICLE

Photo Reference.	Specifications Pin w.x bearing W. x bearing H.	Make	Model no.	Remarks
	30*96*65(L160*12) Pin hole w/o thread (hole one side-12m/m, the other side w/thread)	TCM 10T-13T (Match w/75*200*56)	SR-2230	
	31*58*40(L88*11) Pin hole w/o thread	MITSUBISHI 7T	SR-2235	PCD64
	34*65*26(L70*10) Pin hole w/o thread	心無牙	SR-2209-1	
	34*67*26(L70*10) Pin hole w/o thread	KOMATSU 12S/15S/16S	SR-2209 3EB-71-33260	
	35*94*28(L93*14) 扁心, 14m/m	TOYOTA 5/6FD35/40	SR-2250	PCD50
	35*102*65(L160*12) Pin hole w/o thread	TCM 13T	SR-2249	
	40*100*30(L90*10) Pin hole w/thread (Semi-circle, Bias-22m/m)	TOYOTA 7FD40/45	SR-2241 63348-31960-71 76181-30340-71	PCD60
	40*100*30(L97*14.5) Pin hole w/thread	心無牙	SR-2241-1	
	42*80*30(L90*10) Pin hole w/thread	KOMATSU 4T 7S	SR-2246 3EC-71-33910	PCD60
	45*(95+12)*75 (L160*12)	TCM 15T-20T (5型)	SR-2259	附油封 2PCS 45*55*4 m/m

## SPECIAL PURPOSE VEHICLE

Photo Reference.	Specifications Pin w.x bearing W. x bearing H.	Make	Model no.	Remarks
	45*96*75(L160*12) Pin hole w/o thread (hole one side-12m/m, the other side w/thread)	TCM 15T-20T (4型)	SR-2244	
	45*(113+10)*75(L189*12)	TCM 25T	SR-2251	
 40m/m	50*98*82(L157*12)	TCM 24T/28T 心無牙	SR-2261	附墊片









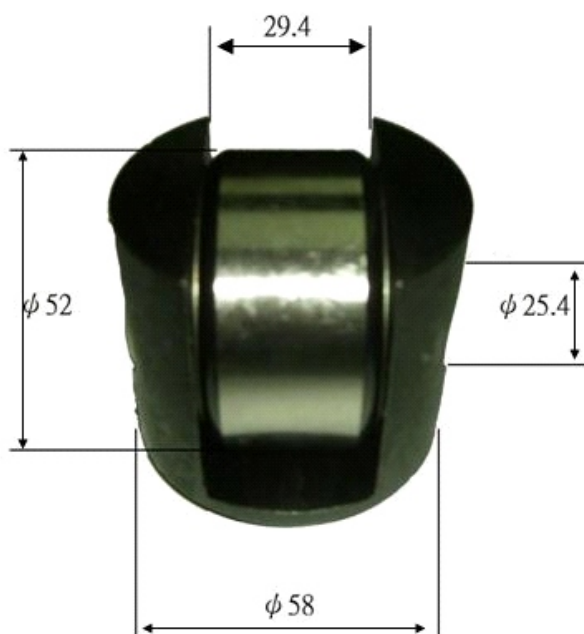

## SPECIAL PURPOSE VEHICLE

### Connecting Seat Bearing



Photo Example □ Dia of Pin Hole -25.4 × 52 H. × 29.4 W. × 58 bottom)

connecting seat



	16*33*22.4*42	TOYOTA FD30	SR-2228	
	16*35*24*40	YALE	SR-2224	
	19*39*30*42.5	TCM FD25	SR-2203 (62036)	
	22*40*26.4*47	TCM NISSAN	SR-2252	
	22*40*26.4*47*44H	NISSAN (有2小油孔)	SR-2252-1	
	22*52*35*66	TCM	SR-2255	
	25*50*52(L115)	TOYOTA 6FD30	SR-2258	

## SPECIAL PURPOSE VEHICLE

	25.4*50*30*54	TCM 6T KOMATSU 6T	SR-2242	
	25.4*52*29.4*58	TCM 4T	SR-2247 DDG63C25 63626-22512	
	25.4*52*30 (L53m/m)	TCM 4T (夾包)	SR-2247-1	

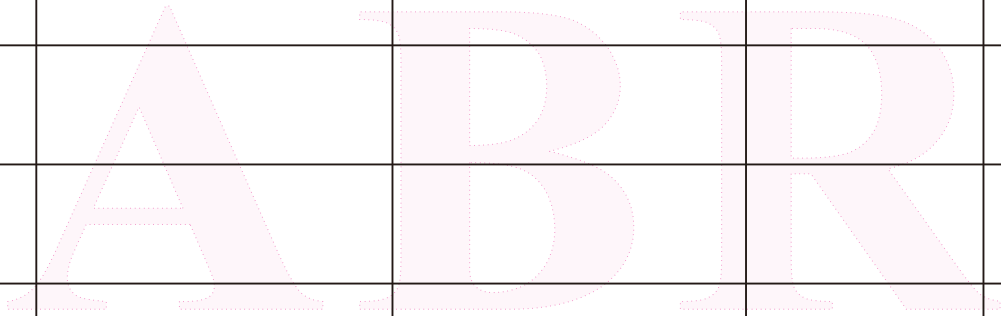

## SPECIAL PURPOSE VEHICLE

	35*102*25 滾輪 (含座)	TCM FD60 Z-7 側導輪座	SR-2262
ABR			

## SPECIAL PURPOSE VEHICLE

### HYDRAULIC PUMP 油壓邦浦 (KAYABA)

OEM NO against Model no of KAYABA Hydraulic Pump

1' / 01	KYB MODEL NO. 1	Remark	OEM NO. 2	KYB MODEL NO. 2	Remark
99371-00300	KRP4-33AEND		67110-22020-71	KRP4-23CSSFD	
	KRP4-33AMJ		13077-10201(A)	KRP4-23CSSBQ	
16442-52021	KRP4-33ASBS		69101-L1403	KRP4-23CV	
91471-36100	KRP4-33AVHH		69101-L1100	KRP4-23CV	
37B-1KB-2030	KRP4-33ASSB		69101-L1404	KRP4-27CV	
78142-33215	KRP4-33ASSB		69101-L1407	KRP4-27CV	
37B-1KB-2031	KRP4-33ASSBDD		69101-L1102	KRP4-27CV	
54452-10401A	KRP4-33ASSBQ		69101-11H01	KRP4-27CVMF	
91471-36100	KRP4-33AVHH		91571-00100	KRP4-30AEND(J)	
L91-60-11510	KRP4-33CSSB		37B-1KB-2020	KRP4-30ASSB	
3EB-60-11510	KRP4-33CSSBDD		37B-1KB-2021	KRP4-30ASSBDD	
15847-10201(A)	KRP4-33CSSBQ		13657-10201(A)	KRP4-30ASSBQ	
15847-39564	KRP4-33CSSBQ		91271-36200	KRP4-30AVHH	
67110-00118-71	KZP4-23CSMFDD		B5910-19009	KRP4-33ASBS	
67110-13600-71	KZP4-23CSMFDD		67110-22020-71	KRP4-23CSSFDN	
67110-22071-71	KZP4-23CSSDD		69101-51K01	KFP22-27CSMSJ	
3BC-60-11110	KZP4-27A		69101-11H00	KRP4-23CVMFJ	
3EB-60-12510	KZP4-27ASSB		691019-11H01	KRP4-27CVMFJ	
3EB-60-12411	KZP4-27ASSSDD		FF200D	KFZ4-25CSKS	
69101-41H00	KZP4-27CSBBF		FF201E	KFZ4-27CSKS	
67110-23640-71	KZP4-27CSMF		FF202F	KFZ4-28.3CSKS	
67110-00268-71	KZP4-27CSMFDD				
67110-32071-71	KZP4-27CSSDN				
67110-32070-71	KZP4-27CSSFDZ				
67110-23021-71	KZP4-27-KRP4-5C				
67110-23860-71	KZP4-28-KRP4-5CF				
67120-03820-71	KZP4-28-KRP4-5CF				
67110-23861-71	KZP4-28-KRP4-5CFDD				
67110-23871-71	KZP4-28CSSDD				
91471-26100	KZP4-33AVH				
126A-10271	DGP22-27CSBEX				
67110-12191-71	DGP4-16C				
H26-1KA-3020	KFP22-23CSMS				
	KFP22-27CSKSJ				
69101-51K01	KFP22-27CSMSN				
133A-10201	KFP22-28CSBS				
114A7-11301	KFP22-30ASBS				
129F1-10301	KFP22-30CSBS				
69101-51K02	KFP22-30CSMSN				
117M7-10321	KFP22-32ASBS				
91771-00100	KFP32-40AMBAS				
91871-32100	KFP32-50AMBSSL				
69101-51H01	KFP32-50ASMSS				
26437-12012B	KFP51-71CSMSF				
3EB-60-11110	KRP4-19CSSB				
3EB-60-11210	KRP4-23CSSB				
37B-1KA-204X	KRP4-23CSSBK				
3ED-60-12251	KRP4-23CSSBKD				

**MEMO**

ABR

## MEMO

ABR